

Specialist for road-and paving jobsites



**Optimas**<sup>®</sup>

# Useful devices and tools

For road, paving and landscaping jobsites!

**Top quality**  
**Fair prices**  
**7 years warranty**



# Content

<b>1</b>	Paver-Cutter / Splitter	page 4
<b>2</b>	Paving tools	page 6
<b>3</b>	Screeding devices	page 9
<b>4</b>	Lifting-and handling tools, mechanical	page 12
<b>5</b>	Transport aid for paver and slabs	page 14
<b>6</b>	Hammers	page 16
<b>7</b>	Useful and cheap tools	page 18
<b>8</b>	Vacuum devices	page 21
<b>9</b>	Formwork systems	page 24

# Paver Cutter / Splitter



## Orit Paver Cutter 330 – 1 Shaft

1 Shaft height adjustment – comfortable and robust,  
2 special hardened cutting knives with 4 cutting edges,  
Splitter table spring-mounted and tiltable

7 years warranty, except wear parts



**Bevel cut**  
no overhang,  
clean edge fitting

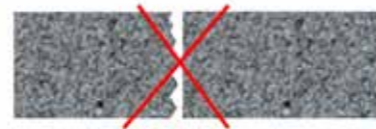

**Vertical cut**  
overhangs,  
no clean edge fitting

### ■ Technical data\*:

Cut width: 33 cm, Cut height: 1 - 12 cm  
Weight: 37 kg

**Art.-no.:** 54391



## Orit Paver Cutter 330 – 2 Shaft

2 Shaft height adjustment - robust and cheap,  
2 hardened blades with 4 cutting edges,  
Splitter table spring-mounted

7 years warranty, except wear parts

### ■ Technical data\*:

Cut width: 33 cm, Cut height: 1 - 12 cm  
Weight: 41 kg

**Art.-no.:** 54143



## Orit Paver Cutter 150 ultra-light

1 Shaft height adjustment – not suitable for strong split forces,  
2 hardened blades with 4 cutting edges,  
non tiltable splitting table

7 years warranty, except wear parts

### ■ Technical data\*:

Cut width: 15 cm, Cut height: 4-8,5 cm  
Weight: 12 kg only

**Art.-no.:** 54141

# Paver Cutter / Splitter

## Orit Paver-and slab cutter 430 – 2 Shaft

2 Shaft height adjustment – suitable for slabs,  
2 hardened blades with 4 cut edges,  
Splitter table spring-mounted

7 years warranty, except wear parts

### ■ Technical data\*:

Cut width: 43 cm, Cut height: 1 - 12 cm  
Weight: 49 kg

**Art.-no.:** 54145



## Orit Clay-and concrete paver cutter 430 with lamella knife

2 Shaft height adjustment , ideal for clay paver  
2 Lamella knife with 17 single teeth  
Splitter table spring-mounted

7 years warranty, except wear parts

### ■ Technical data\*:

Cut width: 43 cm, Cut height: 1 - 12 cm  
Weight: 62 kg

**Art.-no.:** 54144





# Paving Tools



## Optimas Paver Joint Filling Device "Mini 2.0"

"Mini 2.0" is designated mainly for smaller job-sites to completely fill joints in one go. **Only a completely filled joint is able to transmit forces from one paving stone to another and prevent the paving stones from being displaced, thus keeping the paver surface elastic.** "Mini" in true sense of the word... for transportation and storage "Mini" folds down to a small pack.

3 years warranty, except wear parts

### Technical data\*:

- Motor:** Honda GXV160 H2 (4,0 kW at 3600 rpm)
- Fuel:** non-leaded petrol
- Water supply:** external hose pipe, dosage by adjustment valve
- Dimensions:** Working width: 1,07 m, Depth: 73 cm, Height (operation): 96 cm, Height (transport): 57 cm
- Miscellaneous:** Automatic chain tensioning, self-propulsion
- Weight:** 68 kg

**Art.-no.:** 53578



Two rotating brush-crosses generate a slurry of sand and water allowing joints to be filled completely in one go.



Easy to use. Seamless filling of joints without gaps on adjoining walls etc. Perfect job!



Simple height adjustment to bring brushes into correct position for pushing in the sand.

### For a long lasting pavement ...

Optimas „Mini“ a time saving device. Further sanding/brushing in (post-processing) of small areas is absolutely no problem.

### Benefits:

- High quality finished paver surface
- No additional rework
- Fast, cost-effective joints filling
- Effortless joint filling
- Can be used with or without addition of water

# Paving Tools

## Paver-Extractor

Optimas extractor „Simplex“ can be individually pre-set to the stone dimensions 20-30 cm . The blades made of special spring steel can be exchanged.

Due to the even arrangement of the grasps, the applied tractive force is ideally deployed. One further important advantage – if the extractor slips out of the joint, it is virtually impossible to “squash your fingers”.

7 years warranty, except wear parts

### Technical data\*:

Gripping: 20 - 30 cm, Weight: 6 kg

**Art.-no.:** 54432



## Paver Pusher

Useful and robust tool in order to align the joint pattern, if required. Stone pusher features an exchangeable blade made of special hardened spring steel. Due to the upright posture assumed when using the stone pusher, the ergonomics of this work step has been considerably improved.

7 years warranty, except wear parts

### Technical data\*:

Length: 100 cm  
Weight: 2,4 kg

**Art.-no.:** 54433



# Paving Tools

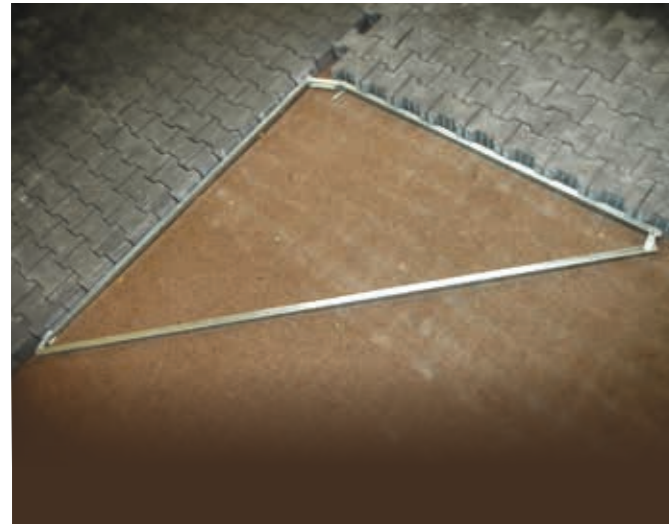

## Optimas Angle-Guide

Optimas Angle-Guide, foldable, for application and control of 90° and 45° angles. Long leg length warrants for accurate work. Very easy and handy for transport.

7 years warranty, except wear parts

### ■ Technical data\*:

Legs: 175 x 175 x 249 cm  
Transport dimensions: 258 x 10 x 30 cm  
Weight: 6,7 kg

**Art.-no.:** 47007



## Optimas Paver-Joint Cleaner

Specially designed for cleaning respectively renovation of paved surfaces. Simple blowing out of joint-material via compressed air. Without splashing pedestrians or vehicles by blown out joint-material.

7 years warranty, except wear parts

### ■ Technical data\*:

Stainless steel housing  
Dimensions: 75 x 36 x 10 cm  
Weight: 25 kg

**Art.-no.:** 54050

# Screeding Devices

## Optimas Mini Screed System

Optimas Mini Screed is the perfect tool to ideally prepare a surface intended for paving. The continuously adjustable modular construction is the innovative alternative to the telescopic principle, which has failed to prove itself in practice in all situations. It enables the clean stripping of the fine grade (sand, chips or similar subgrades) up to a width of 5 metres. This enables you to construct a paving bed that is true to the line in regard to the height and profile.

The Optimas manual levelling screed with levelling guide bars is versatile and can be deployed flexibly, e.g. for footpaths, parking areas, or drive entries.

7 years warranty, except wear parts

### Advantages of Mini-Screed System:

- Working width of 0.25 to 5.20 m continuously adjustable due to modular design
- Clean screeding due to movable side flaps right up to the edge
- Screeding performed via Optimas screed rails (with connector system) or via kerb or gutter stone edges
- Continuous height adjustment on both sides
- High capacity because of bucket shape
- Special bucket shape and ideal pull points avoid the "go up" during screeding.
- Simple and fast mounting, respectively exchange of various intermediate parts
- Hardened and sharpened spring steel blade
- Less space required for transport or storage due to the modular design

## Levelling Screed

Stepless adjustable levelling screed ideal for small areas.

7 years warranty, except wear parts.

### ■ Technical data\*:

Working width: 50 - 90 cm  
Weight: 5 kg

**Art.-no.:** 54146



### ■ Technical data\*:

consisting of 5 intermediate pieces (1,66m, 1,33m, 1,00m, 0,66m, 0,20m) 1 pair wheels with moveable side flaps, (15 cm left and right flap), continuous height adjustment and 2 handles.

**Working width:** 0,20 m - 5,20 m

**Art.-no.:** 47048

### Screed rails:

galvanized incl. connector available in following lengths:  
20 m (6 x 3 m, 2 x 1 m) – **Art.-no:** 52721  
40 m (10 x 3 m, 4 x 2 m, 2 x 1 m) – **Art.-no:** 52722  
60 m (12 x 4m, 4 x 2 m and 4 x 1m) – **Art.-no:** 47037





# Screeding Devices



## Optimas - levelling "Shoe", short

Levelling Shoe is simply attached to a smoothing board. After adjustment of designated screeding level an existing reference as e.g. kerb or gutter is used as guidance. Inefficient cutting of recesses on smoothing boards respectively nailing etc. is a thing of the past.

7 years warranty, except wear parts

Art.-no.: 53437

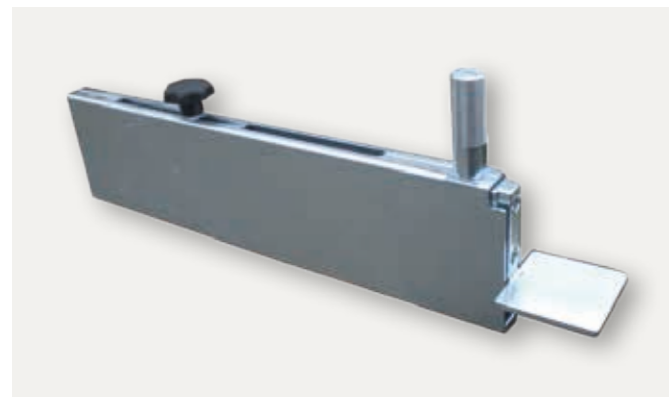

## Optimas - levelling "Shoe", long

In addition to application of levelling „Shoe“, short Optimas offers levelling „Shoe“, long which is equipped with a screeding length adjustment. Adjustment range approx. 25cm. Inefficient cutting of recesses on smoothing boards respectively nailing etc. is a thing of the past.

7 years warranty, except wear parts

Art.-no.: 53440



## Connector for smoothing boards

Provides the possibility to connect 2 smoothing boards etc. Due to the solid design connection of dirty boards is made easily.

7 years warranty, except wear parts

Art.-no.: 53453



## Inclinable limitation

Inclinable limitation is stepless adjustable. This warrants screeding with any slope.

7 years warranty, except wear parts

Art.-no.: 54052

# Screeding Devices

## Egaliner

Egaliner manual screeding system – smooth running system on wheels – fast and easy levelling.

Handy levelling for landscaping, preparation of lawn or seedbed. Different materials as gravel or wood chips can be levelled and distributed quickly and easily as well as fine planum of paving areas.

Handles individually adjustable.  
Sideways stepless, adjustable removeable wheels.

7 years warranty, except wear parts

## Egaliner-120

### ■ Technical data\*:

- 2 x height adjustable wheel-sets
- Outer working width: 700 - 1.200 mm
- Weight: 22 kg

Art.-no.: 54422

## Egaliner-210

### ■ Technical data\*:

- 2 x height adjustable wheel-sets
- 2 x Wheel unit
- Working width: 1.200 - 2.100 mm
- Weight: 29 kg

Art.-no.: 54423



# Lifting-and handling tools mechanical



## Universal Clamp "MAXI"

Deployed for setting of concrete elements such as step treads, concrete and granit kerbs and amongst others also pre-cast concrete elements.

- Simple setting via two locking bolts
- Automatic system „open-close“
- Universal attachment eyelet suitable for all carrier vehicles
- Safe gripping via rubber bars or included Widia pins.

7 years warranty, except wear parts

### ■ Technical data\*:

Gripping range: 5 - 60 cm	Immersion depth: 19 cm
Rubber bars: 35 cm	Lifting capacity: 600 kg
Weight: 33 kg	

Art.-no.: 52318



## Universal-Clamp "MINI" (Type 360 / 420)

Simple mechanical clamp for concrete products handling as footsteps, concrete-or granit kerbs and other concrete products. Galvanized.

- Simple adjustment.
- Universal eyelet for any carrier vehicle
- 2 handles for operation by 2 person
- Safe gripping via rubber bars or included Widia pins.

7 years warranty, except wear parts

### ■ Technical data\*:

	Type 360	Type 420
Gripping range:	0 - 36 cm	0 - 42 cm
Weight:	12 kg	14 kg
Lifting capacity:	550 kg	550 kg
Immersion depth:	up to 14 cm	up to 14 cm

Art.-no.: 54149

Art.-no.: 54427



## Tandem-Kerb Clamp

Exact kerb installation along a guideline. Simply attachable to any construction machine via chain, rope etc.

7 years warranty, except wear parts

### ■ Technical data\*:

Gripping range: 50 - 110 cm	Lifting capacity: 150 kg
Immersion depth: 4 cm	Grip finger width: 10,8 cm
Weight: 12 kg	

Art.-no.: 47098

# Lifting-and handling tools mechanical

## Kerb-Clamp with rubber pad

For precise kerb installation.

7 years warranty, except wear parts

### ■ Technical data\*:

Rubber pads 18 cm, changeable
Length: 82 cm
Immersion depth: 18 cm
Gripping range: 4 - 31 cm
Weight: 4 kg

Art.-no.: 54434



## Kerb-Clamp "Simple"

Robust and cheap.

7 years warranty, except wear parts

### ■ Technical data\*:

Length: 85 cm
Gripping range: 4 - 31 cm
Weight: 2,8 kg

Art.-no.: 54147



## Kerb-Clamp "Widia"

Kerb-Clamp with „Widia“ clamping pin.

7 years warranty, except wear parts

### ■ Technical data\*:

Length: 90 cm
Immersion depth: 20 cm
Gripping range: 4 - 31 cm
Weight: 3 kg

Art.-no.: 54148



## Transport aid for bricks and slabs

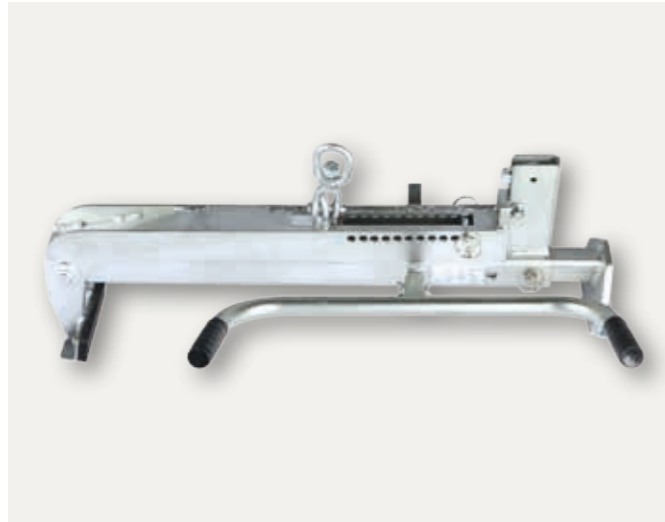

### Kerb-Clamp as attachment for construction machines - mechanical

Kerb-Clamp, mechanical, easy attachable to construction machines  
Simple operation by "open-close" automatic. Equipped with large handle for easy guidance.

7 years warranty, except wear parts

#### ■ Technical data\*:

Gripping range: 75 cm - 120 cm  
Immersion depth: 12,5 cm  
Lifting capacity: 200 kg  
Weight: 21 kg

Art.-no.: 54047



### Universal Manual-Clamp

Clamp for lifting and handling of kerbs and all additional job-site elements. Safe gripping via rubber pads or with Widia pins.

7 years warranty, except wear parts

#### ■ Technical data\*:

Immersion depth: 21 cm  
Gripping range: 0 - 59 cm  
Lifting capacity: 200 kg  
Weight: 12 kg

Art.-no.: 54142



### Hand-Tong

Individually adjustable and easy transport several pieces of concrete and clay paver as well as sand-lime bricks.

7 years warranty, except wear parts

#### ■ Technical data\*:

Gripping range: 29 - 49 cm  
Lifting capacity: 30 kg  
Weight: 1,7 kg

Art.-no.: 54435

## Transport aid for paver and slabs

### Paver - Cart incl. extension

easy transportation of blocks, bricks etc.  
Simple loading via mechanical leverage.  
Incl. extension kit until gripping width of up to 125 cm.  
Incl. 3-wheel mechanism aids stability and pushing.  
Ideal „brickstock“ patch- and cutwork.

7 years warranty, except wear parts

#### ■ Technical data\*:

Dimensions: 175 cm x 125 cm x 65 cm  
Lifting capacity: 450 kg  
Gripping width: 53 - 92 cm / 125 cm with extension  
Storage-place height: 92 cm  
Weight: 65 kg

Art.-no.: 54150



### Slab installation cart, adjustable

For simple transport and installation of slabs.

7 years warranty, except wear parts

#### ■ Technical data\*:

Gripping range: 30 - 100 cm  
Lifting capacity: 120 kg  
Weight: 15 kg

Art.-no.: 54151





# Hammers



## Optimas Paving Hammer (long shafted)

Paving Hammer (long shafted) with 2 rubber pads handy aid for paver installation and alignment of paver. With the squared rubber pads hammer can be placed upright. No bending over.

7 years warranty, except wear parts

### ■ Technical data\*:

Length: 80 cm  
Width: 5,5 cm  
Weight: 3 kg

Art.-no.: 47136

## Optimas Paving Hammer (short shafted)

Paving Hammer (short shafted) with 2 rubber pads handy aid for paver- and kerb installation.

7 years warranty, except wear parts

### ■ Technical data\*:

Length: 40 cm  
Weight: 2,4 kg

Art.-no.: 50075



## Tamping Tool

7 years warranty, except wear parts

### ■ Technical data\*:

Material: Nylon, Weight: 3 kg

Art.-no.: 54152



## Hammer Nylon

7 years warranty, except wear parts

### ■ Technical data\*:

Material: Nylon, Weight: 1,2 kg

Art.-no.: 54154

# Hammers

## Back Lash Hammer

7 years warranty, except wear parts

### ■ Technical data\*:

Length: 21 cm  
Width: 5,5 cm  
Weight: 0,8 kg

Art.-no.: 54153



## Stoning Hammer

with fiberglass safety shaft.

7 years warranty, except wear parts

### ■ Technical data\*:

Shaft length: 22 cm  
Dimensions hammer-head (L x W x H): 9,5 cm x 4 cm x 4 cm  
Weight: 1 kg

Art.-no.: 54155



## Sledge Hammer

with fiberglass safety shaft.

7 years warranty, except wear parts

### ■ Technical data\*:

Width hammer-head: 15,5 cm  
Length shaft: 80 cm  
Weight: 6,1 kg

Art.-no.: 54161



## Useful and cheap tools

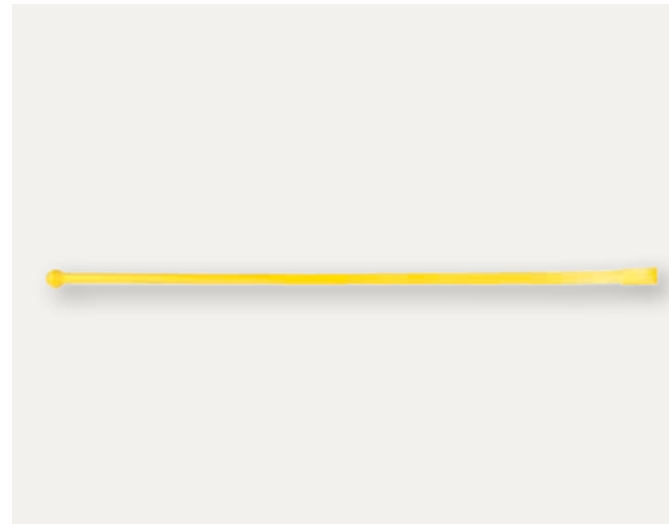

### Crowbar 1400

Ideal aid for kerb installation.  
No spinning of Crowbar because of squared stroke!

7 years warranty, except wear parts

#### ■ Technical data\*:

Length: 140 cm  
Weight: 9 kg

Art.-no.: 54156



### Root Pounder

Ideal for root cutting.

7 years warranty, except wear parts

#### ■ Technical data\*:

Length: 120 cm  
Length hatchet: 26 cm  
Weight: 6,4 kg

Art.-no.: 54157



### Ax with fiberglass shaft

Robust and cheap.

7 years warranty, except wear parts

#### ■ Technical data\*:

Width ax-head: 20 cm  
Length: 70 cm  
Weight: 1,4 kg

Art.-no.: 54158

## Useful and cheap tools

### Hatchet with fiberglass shaft

Robust and cheap.

7 years warranty, except wear parts

#### ■ Technical data\*:

Length: 34 cm  
Width ax-head: 15,5 cm  
Weight: 0,6 kg

Art.-no.: 54159



### Pick Hammer

with fiberglass-and rubber shaft.

7 years warranty, except wear parts

#### ■ Technical data\*:

Length pick: 21 cm  
Length shaft: 90 cm  
Weight: 3,4 kg

Art.-no.: 54160



### Metal Pole, galvanized

7 years warranty, except wear parts

#### ■ Technical data\*:

Length: 100 cm  
Weight: 0,8 kg

Art.-no.: 54162



### Wirepin with loop

galvanized

7 years warranty, except wear parts

#### ■ Technical data\*:

Length: 40 cm  
Weight: 0,3 kg

Art.-no.: 54163

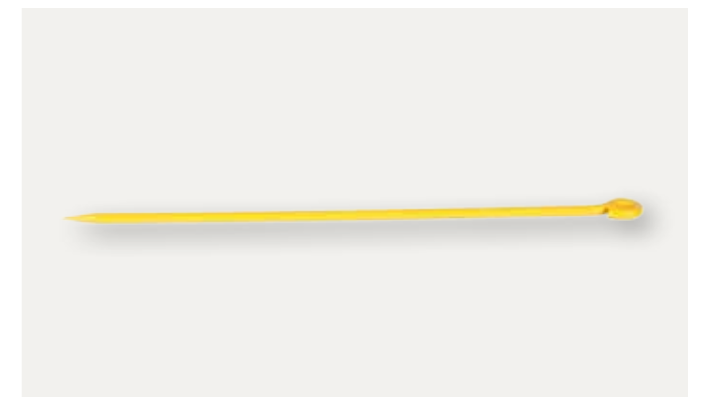



## Useful and cheap tools

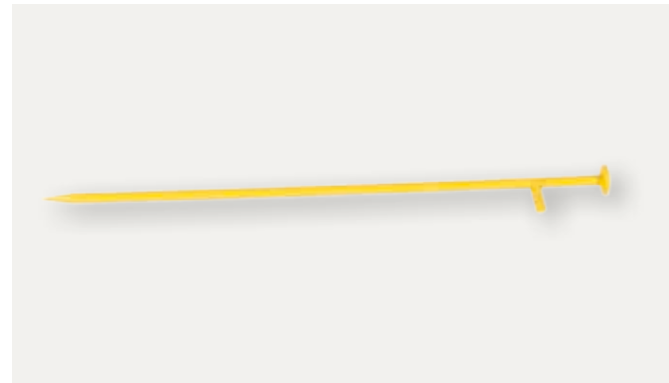

### Wirepin with T-head

Powder coated

7 years warranty, except wear parts

#### ■ Technical data\*:

Length: 40 cm  
Weight: 0,3 kg

Art.-no.: 54165



### Post Rammer Ø112mm

7 years warranty, except wear parts

#### ■ Technical data\*:

Diameter: 11,2 cm  
Length: 75 cm  
Weight: 12,5 kg

Art.-no.: 54166



### Post Rammer Ø162mm

7 years warranty, except wear parts

#### ■ Technical data\*:

Diameter: 16,2 cm  
Length: 75 cm  
Weight: 16,5 kg

Art.-no.: 54167



### Manhole Pole, galvanized

7 years warranty, except wear parts

#### ■ Technical data\*:

Length: 103 cm  
Color: galvanized  
Weight: 1,1 kg

Art.-no.: 54168

## Vacuum devices

### Optimas Vacuum Device SV 200 E

Comfortable handling, lifting and installation of concrete- or natural stone elements up to 200 kg / 440 lb. Even porous material can be lifted. Equipped with two adjustable handles. Simple and gentle body work for operator. With the help of standard eyebolt, device can be attached to any carrier vehicle easily and quickly. Various suction pads for different sizes and weights of slabs, can be exchanged easily. Standard delivery includes a monometer. Operator can indicate anytime, if sufficient vacuum level is given.

3 years warranty, except wear parts

#### ■ Technical data\*:

Drive: Electric 110V/120V or 220V / 230V  
Lifting capacity: 200 kg / 440 lb  
Vacuum pump: 16 m<sup>3</sup>  
Weight: 19 kg  
Features: 2 adjustable handles,  
manometer, eyebolt,  
10 m cable

Art.-no.: 53501



### Suction pads\* SV 200 E

#### ■ Technical data\*:

30 x 40 cm, Lifting capacity at 0,2 bar: 95 kg / 210 lb  
Art.-no.: 53511

#### ■ Technical data\*:

30 x 60 cm, Lifting capacity at 0,2 bar: 150 kg / 330 lb  
Art.-no.: 53512

\*Additional suction pad sizes available on request!

### Frame for SV 200 E and generator EPSi2000

For Optimas vacuum device SV200E and generator EPSi2000 incl. lashing strap and 1 m extension cable. Independent working from electricity supply!

3 years warranty, except wear parts

Art.-no.: 54038

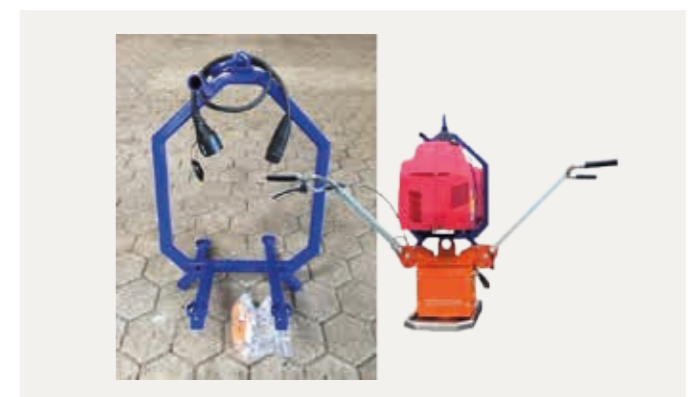

### Generator EPSi2000 for SV200E

Soundproof with Honda petrol engine. Autark drive for SV 200 E device combinable with Optimas Installation-Cart or with frame (see art.-no.: 53894 and 54038).

3 years warranty, except wear parts

Art.-no.: 53907



# Vacuum devices



## Transformer / Inverter 2000 W

for autark drive of SV 200 E with 12 volt battery.

3 years warranty, except wear parts

Art.-no.: 54056



## SV-Installation-Cart for SV 200 E device

Easy installation of loads up to 180 kg by 1 person.

3 years warranty, except wear parts

Art.-no.: 53894

(without vacuum device SV200E and without generator)



## Optimas Vacuum Device SV 250 A

Comfortable handling, lifting and installation of airtight concrete- or natural stone elements up to 250 kg / 550 lb. Simple and gentle body work for operator. Once sufficient vacuum level is reached, vacuum pump shuts off automatically. Result is low battery consumption of battery power and available battery capacity up to 1 working day. With the help of standard eyebolt, device can be attached to any carrier vehicle easily and quickly. Various suction pads for different sizes and weights of slabs, can be exchanged easily. Standard delivery includes a monometer. Operator can indicate anytime, if sufficient vacuum level is given.

3 years warranty, except wear parts

### ■ Technical data\*:

Drive: Battery  
Lifting capacity: 250 kg / 550 lb  
Vacuum pump: 2 m3  
Weight: 21 kg  
Features: 2 adjustable handles, manometer  
voltmeter, eyebolt,  
vakuumentank/-accumulator, charger

Art.-no.: 53500

### Suction pads\* SV 250 A

#### ■ Technical data\*:

30 x 40 cm, Lifting capacity at 0,6 bar: 250 kg / 550 lb

Art.-no.: 53514

\*Additional suction pad sizes available on request!

# Vacuum devices

## Optimas Vacuum Device SV 500 A

Comfortable handling, lifting and installation of airtight concrete- or natural stone elements up to 500 kg / 1.100 lb. Simple and gentle body work for operator. Once sufficient vacuum level is reached vacuum pump shuts off automatically. Result is low battery consumption of battery power and available battery capacity up to 1 working day. With the help of standard eyebolt, device can be attached to any carrier vehicle easily and quickly. Various suction pads for different sizes and weights of slabs, can be exchanged easily. Standard delivery includes a monometer. Operator can indicate anytime, if sufficient vacuum level is given.

3 years warranty, except wear parts

### ■ Technical data\*:

Drive: Battery  
Lifting capacity: 500 kg / 1.100 lb  
Vacuum pump: 2 x 2m3  
Weight: 30 kg  
Features: Handle, manometer, voltmeter,  
eye bolt, vacuum tank/-accumulator,  
charger

Art.-no.: 53502



### Suction pads\* SV 500 A

#### ■ Technical data\*:

40 x 50 cm, Lifting capacity at 0,6 bar: 500 kg / 1.200 lb

Art.-no.: 53511

\*Additional suction pad sizes available on request!



# Formwork Systems



## Concrete Formwork System incl. Sliding Frame

Well prepared concrete backrest for kerbs should determine a sufficient compaction to ensure necessary pressure resistance. To achieve necessary pressure resistance it must be used a formwork system. With Optimas formwork system ideal concrete backrest is prepared easily and quickly. Optimas formwork system is adjustable to all common kerb-sizes. Easy relocation by pulling directly on the kerb via wide pulleys. Set includes a tamper for proper compaction of concrete backrest.

**NEW:** In response to many requests the dirt-susceptible folding mechanism is replaced as of now by the new special trapeze design. No moving parts in working area. Formwork system can be pulled now easily in upright position with the handle. Backfriendly working! Galvanized.

**Your benefits:** Time-and material saving.  
If wished formwork system can be easily extended with a connector.

7 years warranty, except wear parts

Art.-no.: 53642 + 53640



## Optimas Concrete Screeding System incl. Sliding Frame

Easy and exact screeding with **Optimas Concrete Screeding System** of gutter stone concrete base. No matter which wideness, with or without slope, from right to left or viceversa.

With included measuring scale screeding height is determined quickly as well as screeding system adjusted quickly and easily. Easy operation and guidance given by large handle and wide pulleys. Galvanized.

7 years warranty, except wear parts

Art.-no.: 53641 + 53640

# Formwork Systems

## Optimas Concrete Plough

Kerb concrete base screeding before kerb installation.

7 years warranty, except wear parts

### ■ Technical data\*:

Weight: 12 kg

Art.-no.: 47006



## Optimas Formwork Systems

Facilitate and simplify **work processes – that is our goal.**

**Optimas Formwork System** – another example for close cooperation between Optimas and our clients.

### Benefits:

- 20 % concrete saving
- Cutting labour costs
- Simple operation
- Quality increase

7 years warranty, except wear parts

### Formwork profile girder (pic. 1)

Height adjustable

Art.-no.: 50253

### Formwork profile 3,00 m x 0,15 m (pic. 2)

Art.-no.: 50254

### Formwork profile 1,25 m x 0,15 m (pic. 2)

Art.-no.: 50362

### Formwork profile 0,50 m x 0,15 m (pic. 2)

Art.-no.: 50364

### Transport unit, lockable (pic. 3)

(Dimensions: 302 x 87 x 50 cm)

### Loading capacity:

max. 100 m Formwork profile and  
40 pcs. Formwork profile girder

Art.-no.: 50439

## Basic set for 60m formwork

### ■ Technical data\*:

consisting of:  
29 Formwork profile girder (height adjustable),  
16 Formwork profile 3 m x 0,15 m,  
8 Formwork profile 1,25 m x 0,15 m,  
4 Formwork profile 0,50 m x 0,15 m, transport unit

Art.-no.: 50350

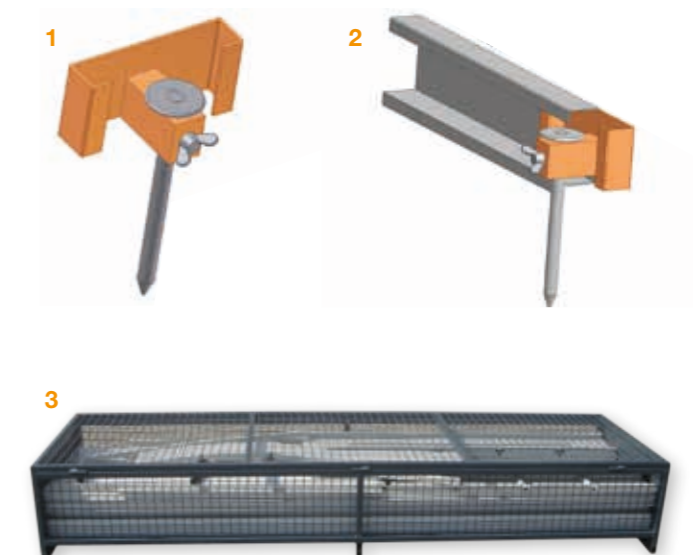

# Formwork Systems



## **Optimas Formwork System Screed up to 50 cm**

Levelling of gutter concrete base

7 years warranty, except wear parts

Art.-no.: 50473





# Optimas<sup>®</sup>

**Optimas Maschinenfabrik  
H. Kleinemas GmbH**

**Industriestraße 12  
26683 Saterland-Ramsloh  
Germany**

*It's so easy to place an order:*

**Tel.: +49 44 98 / 92 42-0**

**Fax: +49 44 98 / 92 42-42**

**[www.optimas.de](http://www.optimas.de)**